



semitron hot line

TOLL FREE NUMBER 800-777-3960

### alloy-junction germanium transistors

Transistor Type	Polarity	Maximum Power (W)	Maximum VCB	Maximum (V) VCE	Typical Gain HFE	Frequency Resp. (MHz)	Case
2N43A	PNP	.240	45	30R	40	1.30	TO-5
2N44A	PNP	.240	45	30R	30	1.00	TO-5
2N107	PNP	.050	12	6	30	.30	TO-5
2N187A	NPN	.075	30	30	50	5.00	TO-5
2N189	NPN	.065	15	15R	48	8.00	TO-5
2N189A	NPN	.065	25	25R	84	9.00	TO-5
2N170	NPN	.025	10	9R	30	4.00	TO-5
2N187A	PNP	.200	25	25R	36	1.00	TO-5
2N188A	PNP	.200	25	25R	50	1.20	TO-5
2N189	PNP	.075	25	25R	36	.80	TO-5
2N190	PNP	.075	25	25R	50	1.00	TO-5
2N191	PNP	.075	25	25R	80	1.20	TO-5
2N192	PNP	.975	25	25R	114	1.50	TO-5
2N21A	PNP	.200	25	25R	80	1.30	TO-5
2N282	NPN	.065	15	15R	21	5.00	TO-5
2N293	NPN	.065	15	15R	38	4.00	TO-5
2N319	PNP	.225	25	20R	34	2.00	TO-5
2N320	PNP	.225	25	20R	50	2.50	TO-5
2N321	PNP	.225	25	20R	80	3.00	TO-5
2N322	PNP	.200	18	18R	50	1.00	TO-5
2N323	PNP	.200	18	18R	80	1.50	TO-5
2N324	PNP	.140	18	18R	130	1.50	TO-5
2N331	PNP	.200	30		60	.40	TO-5
2N381	PNP	.225	50	25R	40	3.00	TO-5
2N382	PNP	.225	50	25R	90	4.00	TO-5
2N383	PNP	.225	50	25R	100	5.00	TO-5
2N388	NPN	.150	25	20	120	5.00	TO-5
2N388A	NPN	.200	40		120	8.00	TO-5
2N394A	PNP	.150	30	10	44	4.00	TO-5
2N395	PNP	.150	30	20R	60	3.00	TO-5
2N396	PNP	.150	20	20R	70	5.00	TO-5
2N396A	PNP	.200	30	20	70	8.00	TO-5
2N397	PNP	.200	30	15R	100	10.00	TO-5
2N398	PNP	.050	105	105S	40	.50	TO-5
2N398A	PNP	.150	105	105S	40	.50	TO-5
2N404	PNP	.150	25	24	40	12.00	TO-5
2N404A	PNP	.150	40	35	50	12.00	TO-5
2N413	PNP	.150	30	18	40	3.00	TO-5
2N41A	PNP	.150	30	15	60	7.00	TO-5
2N426	PNP	.150	30	18	25	6.00	TO-5
2N427	PNP	.150	30	15	25	11.00	TO-5
2N428	PNP	.150	30	12	30	17.00	TO-5
2N460	PNP	.200	45	35	26	1.20	TO-5
2N461	PNP	.200	45	35R	100	2.00	TO-5
2N464	PNP	.150	40	40	26	7.00	TO-5
2N465	PNP	.150	40	30	30	8.00	TO-5
2N466	PNP	.150	35	20	70	1.00	TO-5
2N467	PNP	.200	35	15	140	1.20	TO-5
2N508	PNP	.200	18	16	120	4.50	TO-5
2N508A	PNP	.200	30	30	120	4.50	TO-5
2N524	PNP	.225	45	30R	30	2.50	TO-5
2N525	PNP	.225	45	30R	44	3.00	TO-5
2N526	PNP	.225	45	30R	64	3.50	TO-5
2N527	PNP	.225	45	30	80	4.00	TO-5
2N650	PNP	.200	45	30	50	1.50	TO-5
2N650A	PNP	.200	45	30	50	.75	TO-5
2N651	PNP	.200	45	30	80	2.00	TO-5
2N651A	PNP	.200	45	30	76	1.00	TO-5
2N652	PNP	.200	45	30	120	2.50	TO-5
2N652A	PNP	.200	45	30	120	1.25	TO-5
2N653	PNP	.200	30	20	44	1.50	TO-5
2N654	PNP	.200	30	25	90	2.50	TO-5
2N655	PNP	.200	30	25R	140	2.50	TO-5
2N660	PNP	.200	30	14	100	15.00	TO-5
2N661	PNP	.200	30	9	120	20.00	TO-5
2N662	PNP	.200	30	14	70	8.00	TO-5
2N1008	PNP	.165	20	15R	90	.02	TO-5
2N1008A	PNP	.165	40	35R	100	.02	TO-5
2N1008B	PNP	.165	60	55R	90	.02	TO-5
2N1057	PNP	.240	45		60	.50	TO-5

Transistor Type	Polarity	Maximum Power (W)	Maximum VCB	Maximum (V) VCE	Typical Gain HFE	Frequency Resp. (MHz)	Case
2N1086	NPN	.065	9	9	120	5.00	TO-5
2N1086A	NPN	.065	9	9	120	5.00	TO-5
2N1087	NPN	.065	9	9	120	5.00	TO-5
2N1087	PNP	.200	18	18	60	1.00	TO-5
2N1088	PNP	.200	18	17	50	1.00	TO-5
2N1175	PNP	.200	35	25R	90	1.50	TO-5
2N1175A	PNP	.200	35	25R	90	1.50	TO-5
2N1185	PNP	.200	45	30R	170	1.75	TO-5
2N1186	PNP	.200	60	45R	44	.75	TO-5
2N1187	PNP	.200	60	45R	75	1.00	TO-5
2N1188	PNP	.200	60	45R	115	1.25	TO-5
2N1189	PNP	.200	45	30R	90	1.75	TO-5
2N1190	PNP	.200	45	30R	136	2.25	TO-5
2N1191	PNP	.200	40	25R	60	1.50	TO-5
2N1192	PNP	.200	40	25R	74	2.00	TO-5
2N1193	PNP	.200	40	25R	145	2.50	TO-5
2N1194	PNP	.200	40	25R	275	3.00	TO-5
2N1273	PNP	.150	15	15	100	1.00	TO-5
2N1274	PNP	.150	25	25	100	1.00	TO-5
2N1302	NPN	.150	25	25	50	3.00	TO-5
2N1303	PNP	.150	25	25	50	3.00	TO-5
2N1304	NPN	.150	25	25	70	5.00	TO-5
2N1305	PNP	.150	25	25	70	5.00	TO-5
2N1308	NPN	.150	25	25	100	10.00	TO-5
2N1307	PNP	.150	25	25	100	10.00	TO-5
2N1308	NPN	.150	25	25	150	15.00	TO-5
2N1309	PNP	.150	25	25	150	15.00	TO-5
2N1310	NPN	.120	90		42	2.40	TO-5
2N1311	NPN	.120	75		38	2.20	TO-5
2N1312	NPN	.120	50		46	2.60	TO-5
2N1372	PNP	.250	25	25	60	.75	TO-5
2N1373	PNP	.250	45	45	60	.75	TO-5
2N1374	PNP	.250	25	25	90	1.00	TO-5
2N1375	PNP	.250	45	45	90	1.00	TO-5
2N1376	PNP	.250	25	25	100	1.00	TO-5
2N1377	PNP	.250	45	45	100	1.00	TO-5
2N1378	PNP	.250	12	12	200	1.50	TO-5
2N1379	PNP	.250	25	25	200	1.50	TO-5
2N1380	PNP	.250	12	12	100	1.50	TO-5
2N1381	PNP	.250	25	25	100	1.50	TO-5
2N1382	PNP	.250	25	25	90	2.00	TO-5
2N1383	PNP	.200	25	25	72	1.50	TO-5
2N1404	PNP	.200	25	25	60	4.00	TO-5
2N1406	PNP	.150	50	50S	20	AUD	TO-5
2N1413	PNP	.200	35	25R	36	.80	TO-5
2N1414	PNP	.200	35	25	52	1.00	TO-5
2N1415	PNP	.200	35	25	72	1.30	TO-5
2N1605	NPN	.150	25	24	70	4.00	TO-5
2N1614	PNP	.240	65	40R	30	1.50	TO-5
2N1705	PNP	.200	18	12R	110	4.00	TO-5
2N1706	PNP	.200	25	18R	90	3.00	TO-5
2N1707	PNP	.200	30	25R	90	3.00	TO-5
2N1808	NPN	.150	25	25	120	4.00	TO-5
2N1924	PNP	.225	60	40R	50	1.00	TO-5
2N1925	PNP	.225	60	40R	70	1.30	TO-5
2N1926	PNP	.225	60	40R	96	1.50	TO-5
2N1997	PNP	.250	45	40	120	3.00	TO-5
2N1998	PNP	.250	35	35	150	5.00	TO-5
2N1999	PNP	.250	30	20	220	8.00	TO-5
2N2000	NPN	.300	50	20	160	2.00	TO-5
2N2001	NPN	.300	30	20	200	6.00	TO-5
2N2042	PNP	.200	105	105S	40	.50	TO-5
2N2043	PNP	.200	105	105S	90	.75	TO-5
2N2171	PNP	.225	50	25R	180	7.50	TO-5
2N3427	PNP	.200	45	30R	210	4.00	TO-5
2N3428	PNP	.200	45	30R	260	5.00	TO-5

## case outline drawings

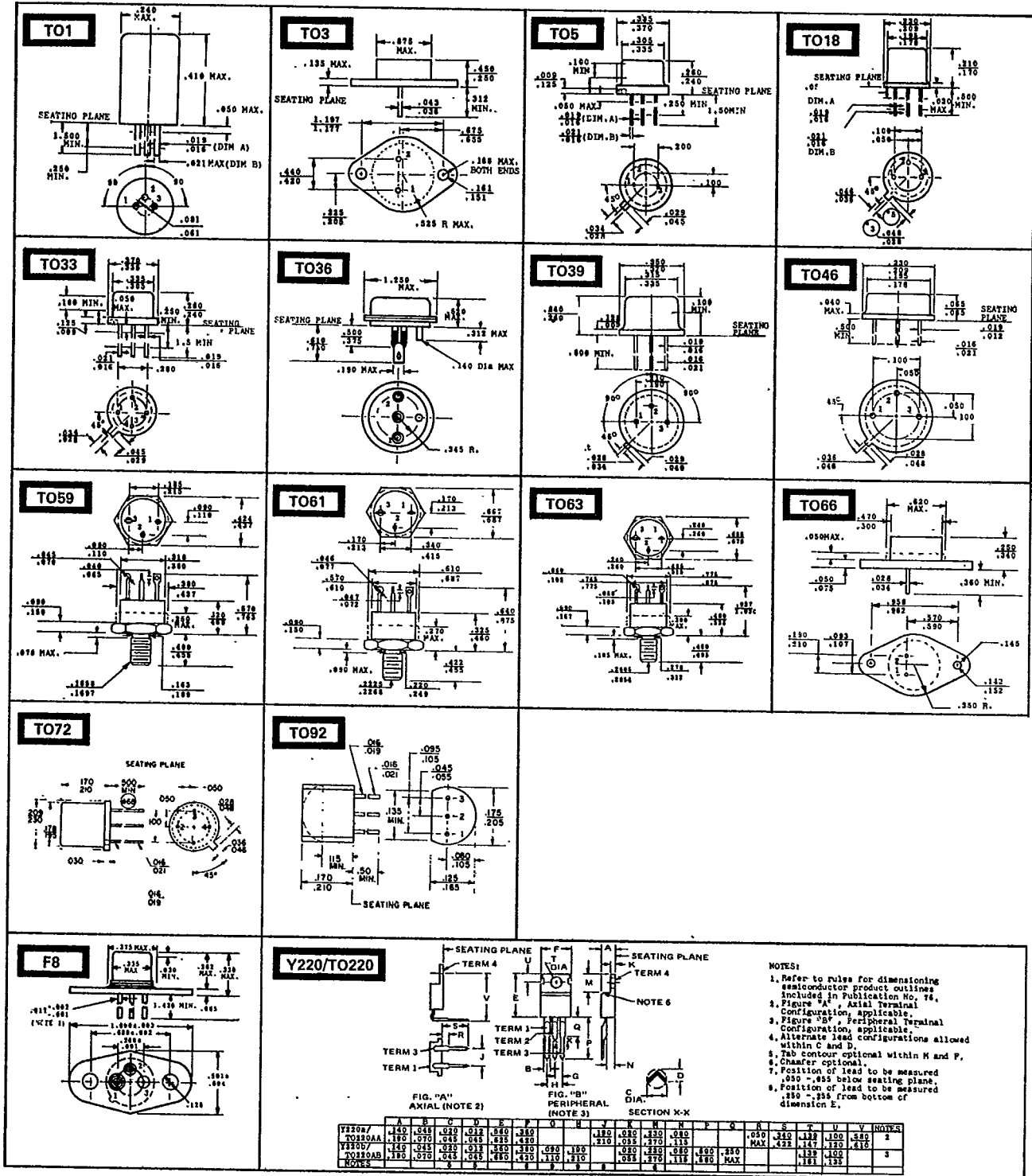



case outline drawings cont'd

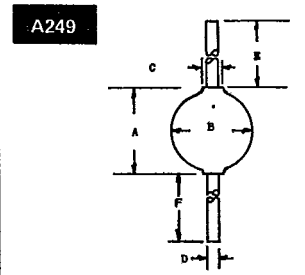
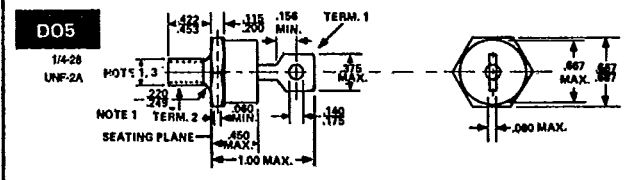
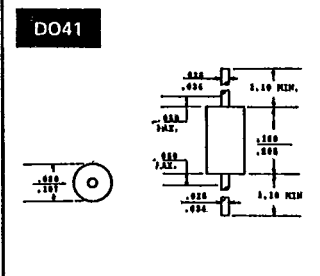
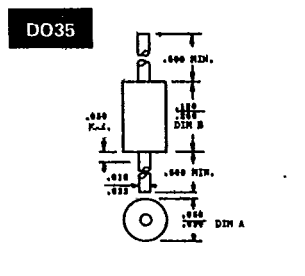
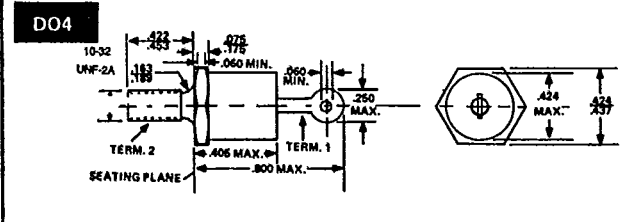
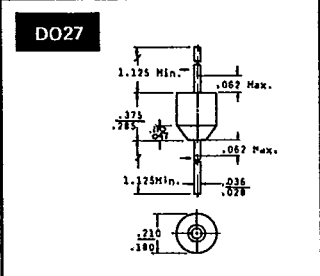
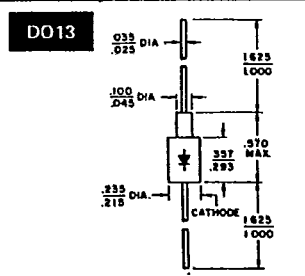
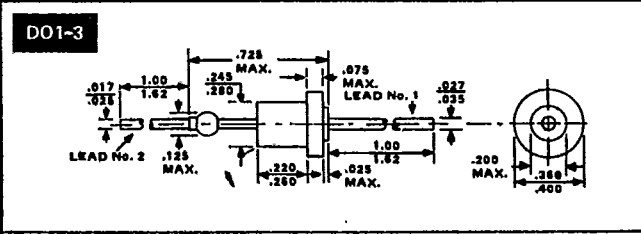

	A	B	C	D	E	F
AR48	1.10	1.10	1.10	1.10	1.10	1.10
AR48M	1.10	1.10	1.10	1.10	1.10	1.10
AR48B	1.10	1.10	1.10	1.10	1.10	1.10
AR48C	1.10	1.10	1.10	1.10	1.10	1.10

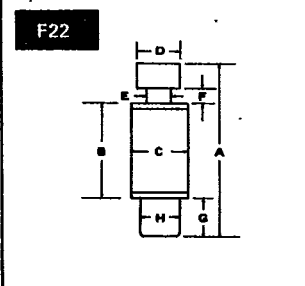
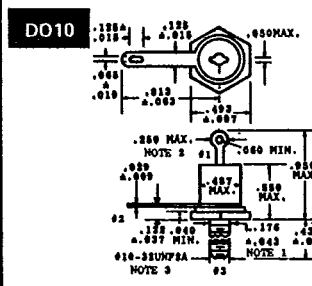
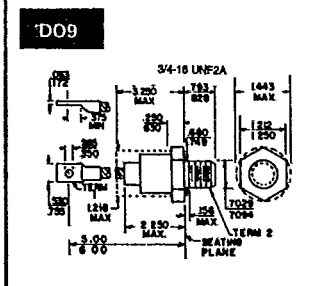
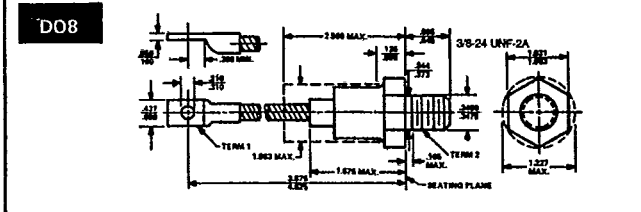
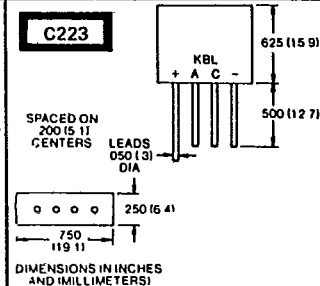
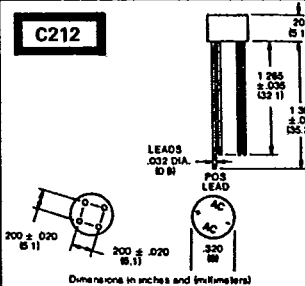
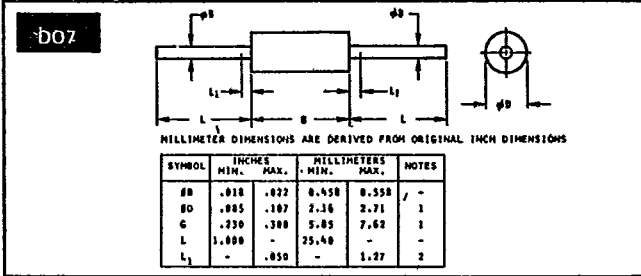

	A	B	C	D	E	F	G	H
F22	1.75	1.60	1.40	1.40	1.00	1.00	1.00	1.00
F22A	1.75	1.60	1.40	1.40	1.00	1.00	1.00	1.00
F22B	1.75	1.60	1.40	1.40	1.00	1.00	1.00	1.00
F22C	1.75	1.60	1.40	1.40	1.00	1.00	1.00	1.00
F22D	1.75	1.60	1.40	1.40	1.00	1.00	1.00	1.00
F22E	1.75	1.60	1.40	1.40	1.00	1.00	1.00	1.00
F22F	1.75	1.60	1.40	1.40	1.00	1.00	1.00	1.00
F22G	1.75	1.60	1.40	1.40	1.00	1.00	1.00	1.00
F22H	1.75	1.60	1.40	1.40	1.00	1.00	1.00	1.00